



**USER MANUAL – EN**

**IN 7120 Inversion table inSPORTline Inverso**



# CONTENTS

SAFETY INSTRUCTIONS..... 3

PARTS LIST ..... 4

HARDWARE & TOOLS ..... 5

ASSEMBLY INSTRUCTIONS ..... 6

BALANCING THE INVERSION TABLE ..... 7

USING THE INVERSION TABLE ..... 7

ENVIRONMENT PROTECTION ..... 9

TERMS AND CONDITIONS OF WARRANTY, WARRANTY CLAIMS..... 9

## **SAFETY INSTRUCTIONS**











Before using the product, please, consult your physician. This is extremely important for people with pre-existing medical conditions. Do not use the Confidence Pro Folding Inversion table if you have any of the following conditions:

- Extreme Obesity
- Glaucoma, Retinal Detachment or Conjunctivitis
- Pregnancy
- Spinal Injuries, Cerebral Sclerosis or swollen joints
- Middle Ear Infection
- High Blood pressure, Hypertension, a history of a Stroke or Transient Ischemic Attacks
- Heart or Circulatory Disorders for which you are being treated.
- Hiatus Hernia or Ventral Hernia
- Bone Weaknesses, Osteoporosis, unhealed Fractures, Modularly Pins or Surgically Implanted
- Orthopedic Supports
- Use Anti-Coagulants including Aspirin in high doses

The Inversion Table was designed for optimum safety; however certain precautions apply whenever it is in use.









- Always wear proper sport clothes and boots. Do not wear too loose clothes.
- If at any time you feel weak or dizzy, stop exercising immediately and consult your physician.
- Keep away from kids and pets.
- Use by one person at the time.
- Regularly check all nuts and screw, tighten them if necessary.
- Do not use wear or damaged product.
- Please be sure to monitor your body's symptoms, make sure you come up slowly. If you experience any dizziness this means that you have come up too fast. If you are nauseous come up immediately.
- Place the product on flat and solid ground
- Keep at least 2 m of free space around the product.
- Keep hands and feet away from all moving parts
- Keep loose clothing and jewelry away from all moving parts.

# PARTS LIST

<p><b>A</b></p>  <p>Under frame assembly 1pc</p>	<p><b>B<sub>1</sub></b></p>  <p><b>B<sub>2</sub></b></p>  <p>Bed 1pc</p>	<p><b>C</b></p>  <p>Adjustable boom 1pc</p>	
<p><b>D</b></p>  <p>Handle bar 2pcs</p>	<p><b>E</b></p>  <p>Pivot Arm 2pcs</p>	<p><b>F</b></p>  <p>Protective Cover 2pcs</p>	<p><b>G</b></p>  <p>Belt 1pc</p>
<p><b>H</b></p>  <p>Foot bar 1pc</p>	<p><b>I</b></p>  <p>(Sponge) Heel holder ROD 1pc</p>	<p><b>J</b></p>  <p>(Rubber) Heel holder ROD 1pc</p>	

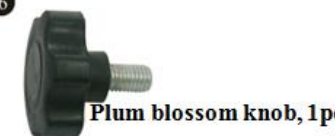
# HARDWARE & TOOLS



<p>1 <math>d+2h+e</math></p>  <p>Screw: M8 × 55, 2sets</p>	<p>2 <math>c+2h+e</math></p>  <p>Screw: M8 × 45, 2sets</p>	<p>3 <math>a+2h+e</math></p>  <p>Screw: M8 × 20, 2sets</p>	
<p>4 <math>b+f+g</math></p>  <p>Screw: M6 × 45, 2sets</p>		<p>6</p>  <p>Plum blossom knob, 1pc</p>	
<p>7</p>  <p>Screw-driver, 1pc</p>	<p>8</p>  <p>Spanner, 1pc</p>	<p>9</p>  <p>Spanner, 1pc</p>	

# ASSEMBLY INSTRUCTIONS

## Step 1

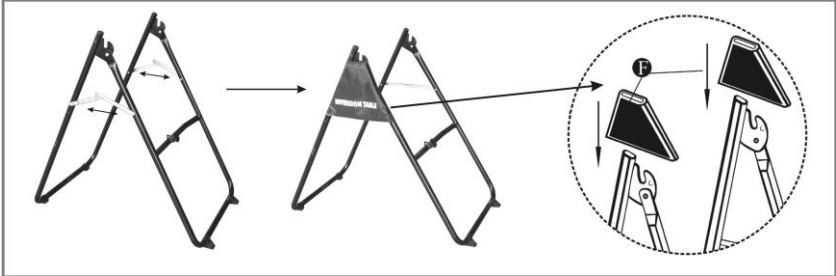

## Step 2

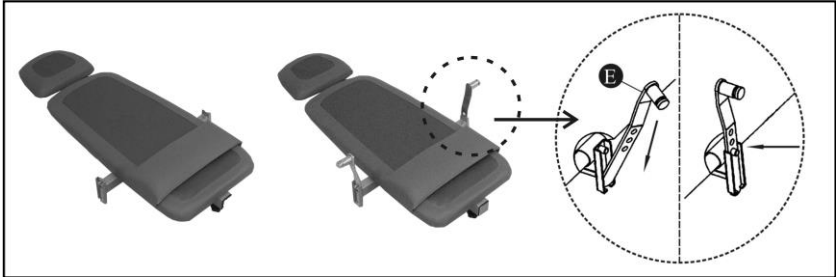

## Step 3

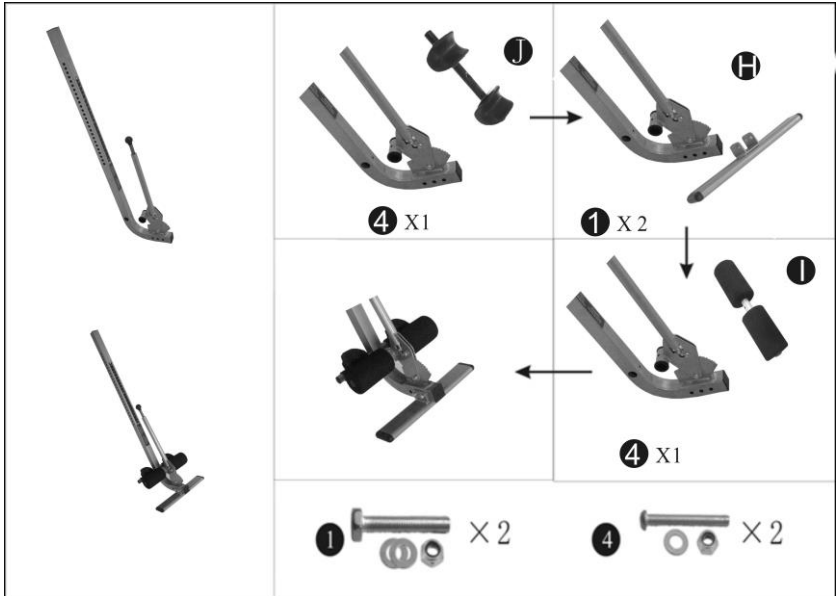

## Step 4

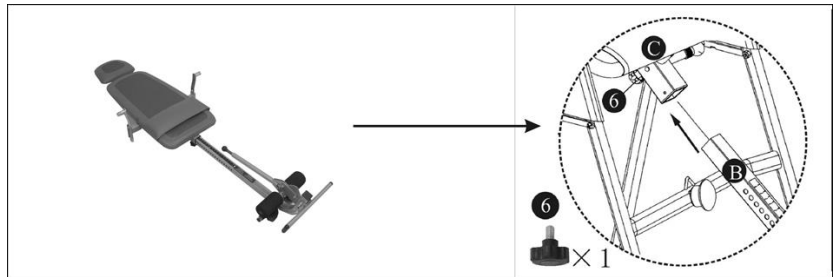

## Step 5



## BALANCING THE INVERSION TABLE

The inversion table is like a very sensitively balanced fulcrum. It responds to very slight changes in weight distribution. So, it is very important to make sure that the height is adjusted properly. To do this, mount the machine, lock your ankles into the heel holders, and lie back with your hands at your sides. Slowly place your hands across your chest. While in this position, your head should still be above your feet. If your feet are above your head, dismount and adjust the height again.

## USING THE INVERSION TABLE

1. Start by lying fully back on the bed with your hands at your side or resting on your thighs.
2. Keeping your hands close to your body begin to raise your arms slowly allowing the table to rotate backward. Stop, or lower your arms to control the downward rotation of the table
3. Raise your arms until they are over your head. At this point, the inversion table will be as far back as it can go.
4. As you get more comfortable, rock the bed slowly by moving your arms up and low slowly.
5. It is recommended that the inversion table be used for five or ten minutes each morning and again each evening.
6. Return to the upright position by slowly moving your hands back down to your thighs.

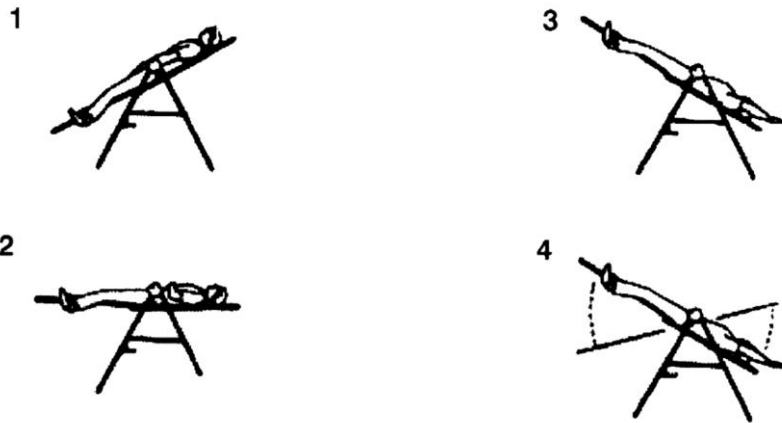

1. **Begin slowly:** invert only 15~20 degrees to begin with. Stay inverted only as long as you are comfortable. Return upright slowly.
2. **Make gradual changes:** Increase the angle only if it is comfortable. Increase angle only a few degrees at a time. Increase the time of use 1~2 minutes up to ten over a period of weeks. Add stretching and light exercise only after you are comfortable with inversion.
3. **Watch your body:** come up slowly. Dizziness after a session means you came up too fast. Wait a while after eating before using table. Coming up immediately if you feel nauseous.
4. **Keep moving:** movement while inverted encourages blood circulation. Movement may be accomplished by either rhythmic traction or light exercise. Do not exercise strenuously while inverted, Limit partial inversion without movement to one or two minutes. Limit full inversion with no movement to only a few seconds.
5. **Invert regularly:** we recommend two or three times a day depending upon your current condition. Try to schedule it for the same times each day.





## ENVIRONMENT PROTECTION

After the product lifespan expired or if the possible repairing is uneconomic, dispose it according to the local laws and environmentally friendly in the nearest scrapyard.

By proper disposal you will protect the environment and natural sources. Moreover, you can help protect human health. If you are not sure in correct disposing, ask local authorities to avoid law violation or sanctions.

## TERMS AND CONDITIONS OF WARRANTY, WARRANTY CLAIMS

### General Conditions of Warranty and Definition of Terms

All Warranty Conditions stated here under determine Warranty Coverage and Warranty Claim Procedure. Conditions of Warranty and Warranty Claims are governed by Act No. 89/2012 Coll. Civil Code, and Act No. 634/1992 Coll., Consumer Protection, as amended, also in cases that are not specified by these Warranty rules.

The seller is SEVEN SPORT s.r.o. with its registered office in Strakonická street 1151/2c, Prague 150 00, Company Registration Number: 26847264, registered in the Trade Register at Regional Court in Prague, Section C, Insert No. 116888.

According to valid legal regulations it depends whether the Buyer is the End Customer or not.

“The Buyer who is the End Customer” or simply the “End Customer” is the legal entity that does not conclude and execute the Contract in order to run or promote his own trade or business activities.

“The Buyer who is not the End Customer” is a Businessman that buys Goods or uses services for the purpose of using the Goods or services for his own business activities. The Buyer conforms to the General Purchase Agreement and business conditions.

These Conditions of Warranty and Warranty Claims are an integral part of every Purchase Agreement made between the Seller and the Buyer. All Warranty Conditions are valid and binding, unless otherwise specified in the Purchase Agreement, in the Amendment to this Contract or in another written agreement.

### Warranty Conditions

#### Warranty Period

The Seller provides the Buyer a 24 months Warranty for Goods Quality, unless otherwise specified in the Certificate of Warranty, Invoice, Bill of Delivery or other documents related to the Goods. The legal warranty period provided to the Consumer is not affected.

By the Warranty for Goods Quality, the Seller guarantees that the delivered Goods shall be, for a certain period of time, suitable for regular or contracted use, and that the Goods shall maintain its regular or contracted features.

#### The Warranty does not cover defects resulting from (if applicable):

- User's fault, i.e. product damage caused by unqualified repair work, improper assembly, insufficient insertion of seat post into frame, insufficient tightening of pedals and cranks
- Improper maintenance
- Mechanical damages
- Regular use (e.g. wearing out of rubber and plastic parts, moving mechanisms, joints, wear of brake pads/blocks, chain, tires, cassette/multi wheel etc.)
- Unavoidable event, natural disaster
- Adjustments made by unqualified person
- Improper maintenance, improper placement, damages caused by low or high temperature, water, inappropriate pressure, shocks, intentional changes in design or construction etc.

## Warranty Claim Procedure

The Buyer is obliged to check the Goods delivered by the Seller immediately after taking the responsibility for the Goods and its damages, i.e. immediately after its delivery. The Buyer must check the Goods so that he discovers all the defects that can be discovered by such check.

When making a Warranty Claim the Buyer is obliged, on request of the Seller, to prove the purchase and validity of the claim by the Invoice or Bill of Delivery that includes the product's serial number, or eventually by the documents without the serial number. If the Buyer does not prove the validity of the Warranty Claim by these documents, the Seller has the right to reject the Warranty Claim.

If the Buyer gives notice of a defect that is not covered by the Warranty (e.g. in the case that the Warranty Conditions were not fulfilled or in the case of reporting the defect by mistake etc.), the Seller is eligible to require a compensation for all the costs arising from the repair. The cost shall be calculated according to the valid price list of services and transport costs.

If the Seller finds out (by testing) that the product is not damaged, the Warranty Claim is not accepted. The Seller reserves the right to claim a compensation for costs arising from the false Warranty Claim.

In case the Buyer makes a claim about the Goods that is legally covered by the Warranty provided by the Seller, the Seller shall fix the reported defects by means of repair or by the exchange of the damaged part or product for a new one. Based on the agreement of the Buyer, the Seller has the right to exchange the defected Goods for a fully compatible Goods of the same or better technical characteristics. The Seller is entitled to choose the form of the Warranty Claim Procedures described in this paragraph.

The Seller shall settle the Warranty Claim within 30 days after the delivery of the defective Goods, unless a longer period has been agreed upon. The day when the repaired or exchanged Goods is handed over to the Buyer is considered to be the day of the Warranty Claim settlement. When the Seller is not able to settle the Warranty Claim within the agreed period due to the specific nature of the Goods defect, he and the Buyer shall make an agreement about an alternative solution. In case such agreement is not made, the Seller is obliged to provide the Buyer with a financial compensation in the form of a refund.

### CZ

#### SEVEN SPORT s.r.o.

Registered Office: Strakonická 1151/2c, Praha 5, 150 00, ČR  
Headquarters: Dělnická 957, Vítkov, 749 01  
Warranty & Service: Čermenská 486, Vítkov 749 01

CRN: 26847264  
VAT ID: CZ26847264

Phone: +420 556 300 970  
E-mail: eshop@insportline.cz  
reklamace@insportline.cz  
servis@insportline.cz

Web: www.inSPORTline.cz

### SK

#### inSPORTline s.r.o.

Headquarters, warranty & service center: Električná 6471, Trenčín 911 01, SK

CRN: 36311723  
VAT ID: SK2020177082

Phone: +421(0)326 526 701  
E-mail: objednavky@insportline.sk  
reklamacie@insportline.sk  
servis@insportline.sk

Web: www.inSPORTline.sk