

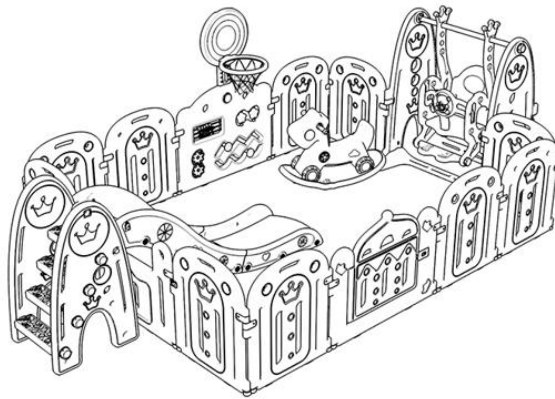

USER MANUAL – EN

IN 26668 Children's plastic playpen with accessories inSPORTline Teutonino 186x236 cm



SevenSport s.r.o. reserves the right to make any changes and improvements to its product without prior notice. Visit our website www.insportline.eu where you will find the latest version of the manual.

SAFETY INSTRUCTIONS

- First read the manual carefully before use and assembly and keep it for future reference.
- Installation may only be carried out by an adult. We recommend that you ask another person for assembly.
- During use, children must be under adult supervision.
- Regularly check all connections and tighten bolts and nuts.
- Do not use a worn or damaged product.
- If sharp edges appear on the product, do not use it.
- Keep sharp edges away around the product.
- Make sure all bolts are protected with rubber caps.
- Use only in areas with enough space to prevent injury to the kids.
- Use only for the purpose for which the product was built.
- Do not stand on the swing, it is intended for sitting only.
- Check the swing attachment points regularly. In case of wear or damage replace them immediately.
- Slide weight limit: 40 kg
- Swing weight limit: 25 kg
- Rocking horse weight limit: 40 kg

- Slide, swing and rocking horse age limit: 3 – 6 years old
- Pen age limit: 6+ months old

ASSEMBLY - FENCE

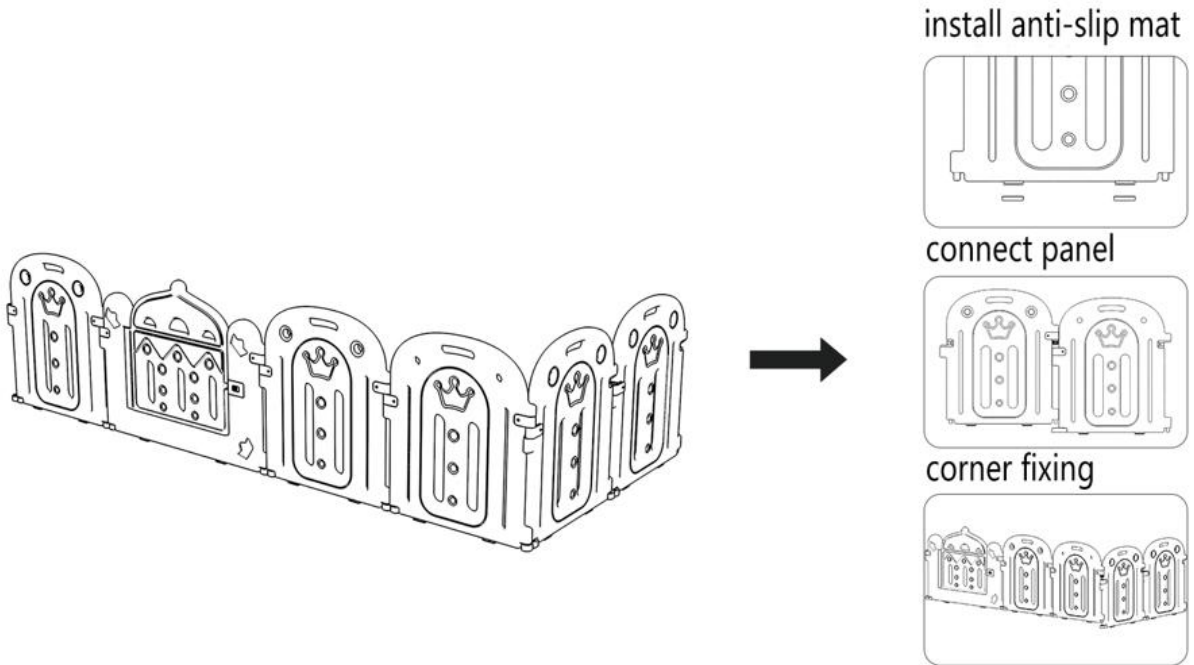

ASSEMBLY - SWING

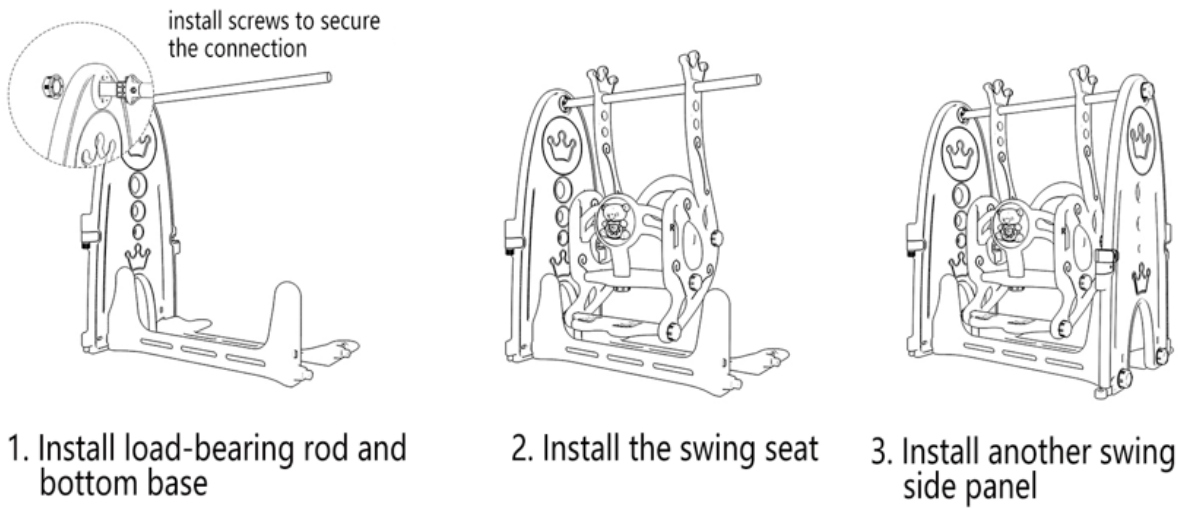

ASSEMBLY – SLIDE

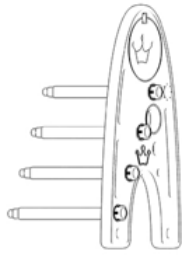

1. Take side panel and step, install with nut

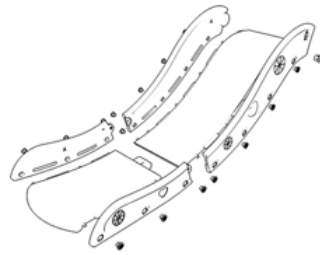

2. Install the slideway handrail

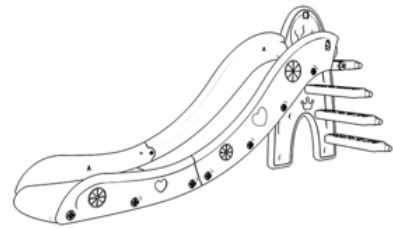

3. Install the slideway

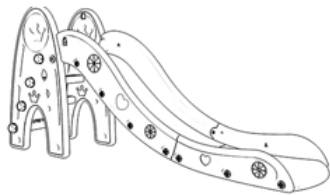

4. Install another side panel

ASSEMBLY – ROCKING HORSE



1. Install handle



2. Install another handle

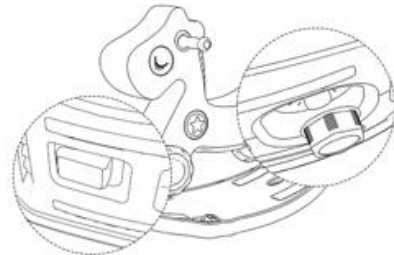

3. Find right position, install horse body and base, fix with nut.



4. Installation finish.

ENVIRONMENT PROTECTION

After the product lifespan expired or if the possible repairing is uneconomic, dispose it according to the local laws and environmentally friendly in the nearest scrapyards.

By proper disposal you will protect the environment and natural sources. Moreover, you can help protect human health. If you are not sure in correct disposing, ask local authorities to avoid law violation or sanctions.

TERMS AND CONDITIONS OF WARRANTY, WARRANTY CLAIMS

General Conditions of Warranty and Definition of Terms

All Warranty Conditions stated here under determine Warranty Coverage and Warranty Claim Procedure. Conditions of Warranty and Warranty Claims are governed by Act No. 89/2012 Coll. Civil Code, and Act No. 634/1992 Coll., Consumer Protection, as amended, also in cases that are not specified by these Warranty rules.

The seller is SEVEN SPORT s.r.o. with its registered office in Strakonická street 1151/2c, Prague 150 00, Company Registration Number: 26847264, registered in the Trade Register at Regional Court in Prague, Section C, Insert No. 116888.

According to valid legal regulations it depends whether the Buyer is the End Customer or not.

“The Buyer who is the End Customer” or simply the “End Customer” is the legal entity that does not conclude and execute the Contract in order to run or promote his own trade or business activities.

“The Buyer who is not the End Customer” is a Businessman that buys Goods or uses services for the purpose of using the Goods or services for his own business activities. The Buyer conforms to the General Purchase Agreement and business conditions.

These Conditions of Warranty and Warranty Claims are an integral part of every Purchase Agreement made between the Seller and the Buyer. All Warranty Conditions are valid and binding, unless otherwise specified in the Purchase Agreement, in the Amendment to this Contract or in another written agreement.

Warranty Conditions

Warranty Period

The Seller provides the Buyer a 24 months Warranty for Goods Quality, unless otherwise specified in the Certificate of Warranty, Invoice, Bill of Delivery or other documents related to the Goods. The legal warranty period provided to the Consumer is not affected.

By the Warranty for Goods Quality, the Seller guarantees that the delivered Goods shall be, for a certain period of time, suitable for regular or contracted use, and that the Goods shall maintain its regular or contracted features.

The Warranty does not cover defects resulting from (if applicable):

- User's fault, i.e. product damage caused by unqualified repair work, improper assembly, insufficient insertion of seat post into frame, insufficient tightening of pedals and cranks
- Improper maintenance
- Mechanical damages
- Regular use (e.g. wearing out of rubber and plastic parts, moving mechanisms, joints, wear of brake pads/blocks, chain, tires, cassette/multi wheel etc.)
- Unavoidable event, natural disaster
- Adjustments made by unqualified person
- Improper maintenance, improper placement, damages caused by low or high temperature, water, inappropriate pressure, shocks, intentional changes in design or construction etc.

Warranty Claim Procedure

The Buyer is obliged to check the Goods delivered by the Seller immediately after taking the responsibility for the Goods and its damages, i.e. immediately after its delivery. The Buyer must check the Goods so that he discovers all the defects that can be discovered by such check.

When making a Warranty Claim the Buyer is obliged, on request of the Seller, to prove the purchase and validity of the claim by the Invoice or Bill of Delivery that includes the product's serial number, or eventually by the documents without the serial number. If the Buyer does not prove the validity of the Warranty Claim by these documents, the Seller has the right to reject the Warranty Claim.

If the Buyer gives notice of a defect that is not covered by the Warranty (e.g. in the case that the Warranty Conditions were not fulfilled or in the case of reporting the defect by mistake etc.), the Seller is eligible to require a compensation for all the costs arising from the repair. The cost shall be calculated according to the valid price list of services and transport costs.

If the Seller finds out (by testing) that the product is not damaged, the Warranty Claim is not accepted. The Seller reserves the right to claim a compensation for costs arising from the false Warranty Claim.

In case the Buyer makes a claim about the Goods that is legally covered by the Warranty provided by the Seller, the Seller shall fix the reported defects by means of repair or by the exchange of the damaged part or product for a new one. Based on the agreement of the Buyer, the Seller has the right to exchange the defected Goods for a fully compatible Goods of the same or better technical characteristics. The Seller is entitled to choose the form of the Warranty Claim Procedures described in this paragraph.

The Seller shall settle the Warranty Claim within 30 days after the delivery of the defective Goods, unless a longer period has been agreed upon. The day when the repaired or exchanged Goods is handed over to the Buyer is considered to be the day of the Warranty Claim settlement. When the Seller is not able to settle the Warranty Claim within the agreed period due to the specific nature of the Goods defect, he and the Buyer shall make an agreement about an alternative solution. In case such agreement is not made, the Seller is obliged to provide the Buyer with a financial compensation in the form of a refund.

**CZ
SEVEN SPORT s.r.o.**

Registered Office: Strakonická 1151/2c, Praha 5, 150 00, ČR
Headquarters: Dělnická 957, Vítkov, 749 01
Warranty & Service: Čermenská 486, Vítkov 749 01

CRN: 26847264
VAT ID: CZ26847264
Phone: +420 556 300 970
E-mail: eshop@insportline.cz
reklamace@insportline.cz
servis@insportline.cz

Web: www.inSPORTline.cz

**SK
inSPORTline s.r.o.**

Headquarters, warranty & service center: Električná 6471,
Trenčín 911 01, SK

CRN: 36311723
VAT ID: SK2020177082
Phone: +421(0)326 526 701
E-mail: objednavky@insportline.sk
reklamacie@insportline.sk
servis@insportline.sk

Web: www.inSPORTline.sk

About shipping

